

16GB DDR4-3200 SO-DIMM 1.2V

260pin PC4-25600 DDR4 Unbuffered SO-DIMM Non-ECC

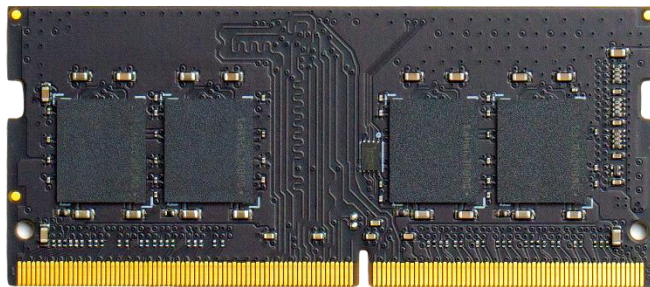
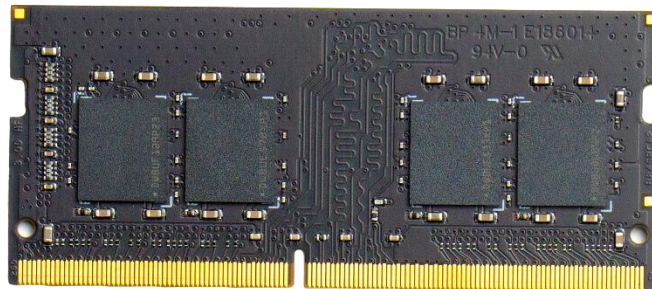



Table of Contents

1. Specifications	1
2. Key Parameters	1
3. Pin Descriptions	2
4. Input/Output Functional Descriptions	3~5
5. Pin Configurations	6~7
6. Functional Block Diagram	8
7. Physical Dimension	9



AMD162GSDQN8

16G Bytes (2048M x 64 bits)

based on 8 pcs 2084M x 8 DDR4 SDRAM

260pin PC4-25600 DDR4 Unbuffered SO-DIMM Non-ECC

Specifications

- RoHS Compliant (Lead Free) Memory module
- Density: 16GB
- Organization
 - 2048M x 64 bits, 1 Rank
- Mounting 8 pieces of 16G bits DDR4 SDRAM sealed In FBGA
- Package: 260-pin, Small Outline Dual in-line memory module (SO-DIMM) — PCB height: 30.00mm
 - PCB Gold Plating: 3u" min
- Power Supply: VDD=1.2V (1.14V to 1.26V)
- VDDQ = 1.2V (1.14V to 1.26V)
- VPP = 2.5V (2.375V to 2.75V)
- VDDSPD=2.25V to 2.75V
- Functionality and operations comply with the DDR4 SDRAM datasheet
- 16 internal banks
- Bank Grouping is applied, and CAS to CAS latency (tCCD_L, tCCD_S) for the banks in the same or different bank group accesses are available
- Fast data transfer rates: PC4-25600
- Bi-Directional Differential Data Strobe
- 8 bit pre-fetch
- Burst Length (BL) switch on-the-fly BL8 or BC4(Burst Chop)
- CAS (READ) latency (CL): 14, 15, 16, 17, 18,19 ,20 ,21 ,22
- On-Die Termination (ODT)
- Terminated control command and address bus
- Tcase of 0°C to 95°C (Components)
 - 64ms, 8,192 cycle refresh at 0°C to 85°C — 32ms at 85°C to 95°C
- Operating Temperature (Tcase) — TOPR = 0°C to +85°C
- Fly-by topology

Key Parameters

MT/s	tCK (ns)	CAS Latency (tCK)	tRCD (ns)	tRP (ns)	tRAS (ns)	tRC (ns)	CL-tRCD-tRP
DDR4-3200	0.62	22	13.75	13.75	32	45.75	22-22-22

Pin Descriptions

Pin Name	Description	Pin Name	Description
A0-A16	SDRAM address bus	SCL	I2C serial bus clock for SPD/TS and register
BA0, BA1	SDRAM bank select input	SDA	I2C serial data line for SPD/TS and register
BG0, BG1	SDRAM bank group select input	SA0-SA2	I2C slave address select for SPD/TS and register
RAS_n2	SDRAM row address strobe input	PAR	SDRAM parity input
CAS_n3	SDRAM column address strobe input	VDD	SDRAM core power
WE_n4	SDRAM write enable input		
CS0_n, CS1_n, CS2_n, CS3_n	DIMM Rank Select Lines input	12V	Optional Power Supply on socket but not used on RDIMM
CKE0, CEK1	SDRAM clock enable lines input	VREFCA	SDRAM command/address reference supply
ODT0, ODT1	SDRAM on-die termination control lines input	VSS	Power supply return (ground)
ACT_n	SDRAM input for activate input	VDDSPD	Serial SPD/TS positive power supply
DQ0-DQ63	DIMM memory data bus	ALERT_n	SDRAM ALERT_n output
CB0-CB7	DIMM ECC check bits	VPP	SDRAM Supply
TDQS9_t-TDQS17_t TDQS_c-TDQS17_c	Dummy loads for mixed populations of x4 based and x8 based RDIMMs.		
DQS0_t-DQS17_t	Data Buffer data strobes (positive line of differential pair)	RESET_n	Set SDRAM and SDRAMs to a Known State
DBI0_n-DBI8_n	Data Bus Inversion	EVENT_n	SPD signals a thermal event has occurred
CK0_t, CK1_t	SDRAM clock input (positive line of differential pair)	VTT	SDRAM I/O termination supply
CK0_c, CK1_c	SDRAM clock input (negative line of differential pair)	RFU	Reserved for future use

1. RAS_n is a multiplexed function with A16.
2. CAS_n is a multiplexed function with A15.
3. WE_n is a multiplexed function with A14.

Input/Output Functional Descriptions

Symbol	Type	Function
CK_t, CK_c	Input	Clock: CK_t and CK_c are differential clock inputs. All address and control input signals are sampled on the crossing of the positive edge of CK_t and negative edge of CK_c.
CKE, (CKE1)	Input	Clock Enable: CKE HIGH activates, and CKE Low deactivates, internal clock signals and device input buffers and output drivers. Taking CKE Low provides Precharge Power-Down and Self-Refresh operation (all banks idle), or Active Power-Down (row Active in any bank). CKE is asynchronous for Self-Refresh exit. After VREFCA and VREFDQ have become stable during the power on and initialization sequence, they must be maintained during all operations (including Self-Refresh). CKE must be maintained high throughout read and write accesses. Input buffers, excluding CK, CK_c, ODT and CKE, are disabled during power-down. Input buffers, excluding CKE, are disabled during Self-Refresh.
CS_n, (CS1_n)	Input	Chip Select: All commands are masked when CS_n is registered HIGH. CS_n provides for external Rank selection on systems with multiple Ranks. CS_n is considered part of the command code.
C0,C1,C2	Input	Chip ID: Chip ID is only used for 3DS for 2,4,8high stack via TSV to select each slice of stacked component. Chip ID is considered part of the command code.
ODT, (ODT1)	Input	On Die Termination: ODT (registered HIGH) enables termination resistance internal to the DDR4 SDRAM. When enabled, ODT is only applied to each DQ, DQS_t, DQS_c and DM_n/DBI_n/TDQS_t,NU/TDQS_c (When TDQS is enabled via Mode Register A11=1 in MR1) signal for x8 configurations. For x16 configuration ODT is applied to each DQ, DQSU_c, DQSU_t, DQSL_t, DQSL_c, DMU_n, and DML_n signal. The ODT pin will be ignored if MR1 is programmed to disable RTT_NOM.
ACT_n	Input	Activation Command Input: ACT_n defines the Activation command being entered along with CS_n. The input into RAS_n/A16, CAS_n/A15 and WE_n/A14 will be considered as Row Address A16, A15 and A14.
RAS_n/A16, CAS_n/A15, WE_n/A14	Input	Command Inputs RAS_n/A16, CAS_n/A15 and WE_n/A14 (along with CS_n) define the command being entered. Those pins have multi function. For example, for activation with ACT_n Low, those are Addressing like A16,A15 and A14 but for non-activation command with ACT_n High, those are Command pins for Read, Write and other command defined in command truth table.
DM_n/DBI_n/ TDQS_t, (DMU_n/DBIU_n), (DML_n/DBIL_n)	Input/ Output	Input Data Mask and Data Bus Inversion: DM_n is an input mask signal for write data. Input data is masked when DM_n is sampled LOW coincident with that input data during a Write access. DM_n is sampled on both edges of DQS. DM is muxed with DBI function by Mode Register A10,A11,A12 setting in MR5. For x8 device, the function of DM or TDQS is enabled by Mode Register A11 setting in MR1. DBI_n is an input/output identifying whether to store/output the true or inverted data. If DBI_n is LOW, the data will be stored/output after inversion inside the DDR4 SDRAM and not inverted if DBI_n is HIGH. TDQS is only supported in x8.
BG0 - BG1	Input	Bank Group Inputs: BG0 - BG1 define to which bank group an Active, Read, Write or Precharge command is being applied. BG0 also determines which mode register is to be accessed during a MRS cycle. x4/8 have BG0 and BG1 but x16 has only BG0.

Input/Output Functional Descriptions

Symbol	Type	Function
BA0 - BA1	Input	Bank Address Inputs: BA0 - BA1 define to which bank an Active, Read, Write or Precharge command is being applied. Bank address also determines if the mode register or extended mode register is to be accessed during a MRS cycle.
A0 - A16	Input	Address Inputs: Provided the row address for ACTIVATE Commands and the column address for Read/Write commands to select one location out of the memory array in the respective bank. (A10/AP, A12/BC_n, RAS_n/A16, CAS_n/A15 and WE_n/A14 have additional functions, see other rows. The address inputs also provide the op-code during Mode Register Set commands.
A10 / AP	Input	Auto-precharge: A10 is sampled during Read/Write commands to determine whether Autoprecharge should be performed to the accessed bank after the Read/Write operation. (HIGH: Autoprecharge; LOW: no Autoprecharge). A10 is sampled during a Precharge command to determine whether the Precharge applies to one bank (A10 LOW) or all banks (A10 HIGH). If only one bank is to be precharged, the bank is selected by bank addresses.
A12 / BC_n	Input	Burst Chop: A12 / BC_n is sampled during Read and Write commands to determine if burst chop (on-the-fly) will be performed. (HIGH, no burst chop; LOW: burst chopped). See command truth table for details.
RESET_n	Input	Active Low Asynchronous Reset: Reset is active when RESET_n is LOW, and inactive when RESET_n is HIGH. RESET_n must be HIGH during normal operation. RESET_n is a CMOS rail to rail signal with DC high and low at 80% and 20% of VDD.
DQ	Input/ Output	Data Input/ Output: Bi-directional data bus. If CRC is enabled via Mode register then CRC code is added at the end of Data Burst. Any DQ from DQ0~DQ3 may indicate the internal Vref level during test via Mode Register Setting MR4 A4=High. Refer to vendor specific datasheets to determine which DQ is used.
DQS_t, DQS_c, DQSU_t, DQSU_c, DQSL_t, DQSL_c	Input/ Output	Data Strobe: output with read data, input with write data. Edge-aligned with read data, centered in write data. For x16, DQSL corresponds to the data on DQL0-DQL7; DQSU corresponds to the data on DQU0-DQU7. The data strobe DQS_t, DQSL_t, and DQSU_t are paired with differential signals DQS_c, DQSL_c, and DQSU_c, respectively, to provide differential pair signaling to the system during reads and writes. DDR4 SDRAM supports differential data strobe only and does not support single-ended.
TDQS_t, TDQS_c	Output	Termination Data Strobe: TDQS_t/TDQS_c is applicable for x8 DRAMs only. When enabled via Mode Register A11 = 1 in MR1, the DRAM will enable the same termination resistance function on TDQS_t/TDQS_c that is applied to DQS_t/DQS_c. When disabled via mode register A11 = 0 in MR1, DM/DBI/TDQS will provide the data mask function or Data Bus Inversion depending on MR5; A11, 12, 10 and TDQS_c is not used. x4/x16 DRAMs must disable the TDQS function via mode register A11 = 0 in MR1.
PAR	Input	Command and Address Parity Input : DDR4 Supports Even Parity check in DRAMs with MR setting. Once it's enabled via Register in MR5, then DRAM calculates Parity with ACT_n, RAS_n/A16, CAS_n/A15, WE_n/A14, BG0-BG1, BA0-BA1, A17-A0. Input parity should maintain at the rising edge of the clock and at the same time with command & address with CS_n LOW.

Input/Output Functional Descriptions

Symbol	Type	Function
ALERT_n	Output	Alert: It has multi functions such as CRC error flag, Command and Address Parity error flag. If there is error in CRC, then Alert_n goes LOW for the period time interval and goes back HIGH. IF there is error in Command Address Parity Check, then Alert_n goes LOW for relatively long period until on going DRAM internal recovery transaction to complete.
TEN	Input	Boundary Scan Mode Enable: Required on x16 devices and optional input on x4/x8 with densities equal to or greater than 8Gb. HIGH in this pin will enable boundary scan operation along with other pins. It is a CMOS rail to rail signal with DC high and low at 80% and 20% of VDD.
NC		No Connect: No internal electrical connection is present.
VDDQ	Supply	DQ Power Supply: 1.2 V +/- 0.06 V
VSSQ	Supply	DQ Ground
VDD	Supply	Power Supply: 1.2 V +/- 0.06 V
VSS	Supply	Ground
V _{pp}	Supply	DRAM Activation Power Supply: 2.5V (2.375V min , 2.75 max)
VREFCA	Supply	Reference voltage for CA
ZQ	Supply	Reference Pin for ZQ calibration

Note: Input only pins (BG0-BG-1, BA0-BA1, A0-A17, ACT_n, RAS_n/A16, CAS_n/A15, WE_n/A14, CS_n, CKE, ODT, and RESET_n) do not supply termination.

Pin Configurations

Pin	Front Side Pin Label	Pin	Back Side Pin Label	Pin	Front Side Pin Label	Pin	Back Side Pin Label
1	VSS	2	VSS	131	A3	132	A2
3	DQ5	4	DQ4	133	A1	134	EVENT_n
5	VSS	6	VSS	135	VDD	136	VDD
7	DQ1	8	DQ0	137	CK0_t	138	CK1_t
9	VSS	10	VSS	139	CK0_c	140	CK1_c
11	DQS0_c	12	DM0_n/DBI0_n, NC	141	VDD	142	VDD
13	DQS0_t	14	VSS	143	PARITY	144	A0
15	VSS	16	DQ6	KEY			
17	DQ7	18	VSS				
19	VSS	20	DQ2	145	BA1	146	A10/AP
21	DQ3	22	VSS	147	VDD	148	VDD
23	VSS	24	DQ12	149	CS0_n	150	BA0
25	DQ13	26	VSS	151	A14/WE_n	152	A16/RAS_n
27	VSS	28	DQ8	153	VDD	154	VDD
29	DQ9	30	VSS	155	ODT0	156	A15/CAS_n
31	VSS	32	DQS1_c	157	CS1_n	158	A13
33	DM1_n/DBI1_n, NC	34	DQS1_t	159	VDD	160	VDD
35	VSS	36	VSS	161	ODT1	162	C0, CS2_n, NC
37	DQ15	38	DQ14	163	VDD	164	VREFCA
39	VSS	40	VSS	165	C1, CS3_n, NC	166	SA2
41	DQ10	42	DQ11	167	VSS	168	VSS
43	VSS	44	VSS	169	DQ37	170	DQ36
45	DQ21	46	DQ20	171	VSS	172	VSS
47	VSS	48	VSS	173	DQ33	174	DQ32
49	DQ17	50	DQ16	175	VSS	176	VSS
51	VSS	52	VSS	177	DQS4_c	178	DM4_n/DBI4_n, NC
53	DQS2_c	54	DM2_n/DBI2_n, NC	179	DQS4_t	180	VSS
55	DQS2_t	56	VSS	181	VSS	182	DQ39
57	VSS	58	DQ22	183	DQ38	184	VSS
59	DQ23	60	VSS	185	VSS	186	DQ35
61	VSS	62	DQ18	187	DQ34	188	VSS
63	DQ19	64	VSS	189	VSS	190	DQ45
65	VSS	66	DQ28	191	DQ44	192	VSS
67	DQ29	68	VSS	193	VSS	194	DQ41
69	VSS	70	DQ24	195	DQ40	196	VSS
71	DQ25	72	VSS	197	VSS	198	DQS5_c
73	VSS	74	DQS3_c	199	DM5_n/DBI5_n, NC	200	DQS5_t
75	DM3_n/DBI3_n, NC	76	DQS3_t	201	VSS	202	VSS



AMD162GSDQN8

Pin Configurations

Pin	Front Side Pin Label	Pin	Back Side Pin Label	Pin	Front Side Pin Label	Pin	Back Side Pin Label
77	VSS	78	VSS	203	DQ46	204	DQ47
79	DQ30	80	DQ31	205	VSS	206	VSS
81	VSS	82	VSS	207	DQ42	208	DQ43
83	DQ26	84	DQ27	209	VSS	210	VSS
85	VSS	86	VSS	211	DQ52	212	DQ53
87	CB5, NC	88	CB4, NC	213	VSS	214	VSS
89	VSS	90	VSS	215	DQ49	216	DQ48
91	CB1, NC	92	CB0, NC	217	VSS	218	VSS
93	VSS	94	VSS	219	DQS6_c	220	DM6_n/DBI6_n, NC
95	DQS8_c	96	DM8_n/DBI8_n, NC	221	DQS6_t	222	VSS
97	DQS8_t	98	VSS	223	VSS	224	DQ54
99	VSS	100	CB6, NC	225	DQ55	226	VSS
101	CB2, NC	102	VSS	227	VSS	228	DQ50
103	VSS	104	CB7, NC	229	DQ51	230	VSS
105	CB3, NC	106	VSS	231	VSS	232	DQ60
107	VSS	108	RESET_n	233	DQ61	234	VSS
109	CKE0	110	CKE1	235	VSS	236	DQ57
111	VDD	112	VDD	237	DQ56	238	VSS
113	BG1	114	ACT_n	239	VSS	240	DQS7_c
115	BG0	116	ALERT_n	241	DM7_n/DBI7_n, NC	242	DQS7_t
117	VDD	118	VDD	243	VSS	244	VSS
119	A12	120	A11	245	DQ62	246	DQ63
121	A9	122	A7	247	VSS	248	VSS
123	VDD	124	VDD	249	DQ58	250	DQ59
125	A8	126	A5	251	VSS	252	VSS
127	A6	128	A4	253	SCL	254	SDA
129	VDD	130	VDD	255	VDDSPD	256	SA0
				257	VPP	258	VTT
				259	VPP	260	SA1

AMD162GSDQN8

Functional Block Diagram

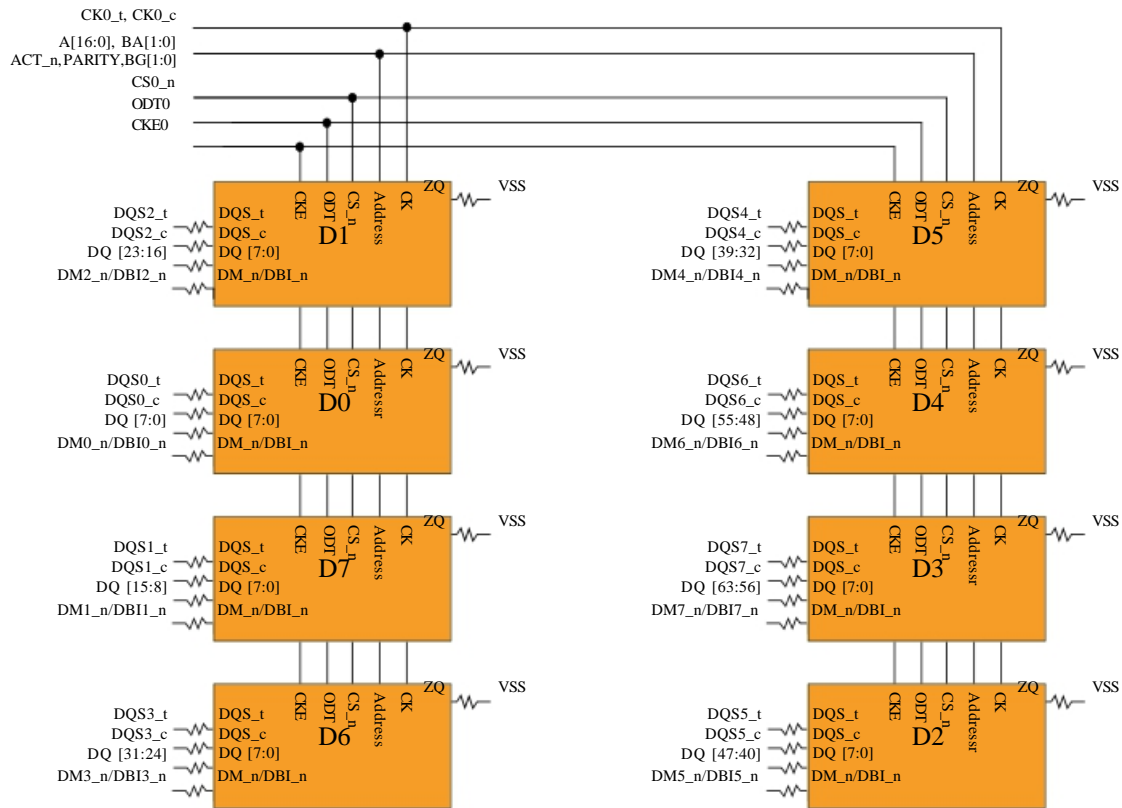

Serial PD with Thermal sensor

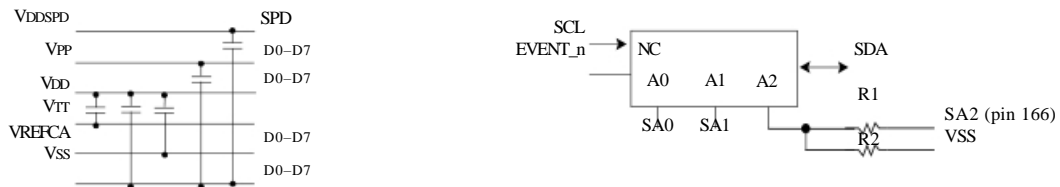

Note:

1. Unless otherwise noted, resistor values are $15\ \Omega \pm 5\%$.
2. ZQ resistors are $240\ \Omega \pm 1\%$. For all other resistor values refer to the appropriate wiring diagram.
3. To connect the SPD A2 input to the edge connector pin 166 install R1. To tie the SPD input A2 to ground install R2. Do not install both R1 and R2. The values for R1 and R2 are not critical. Any value less than 100 Ohms may be used.



AMD162GSDQN8

Physical Dimension

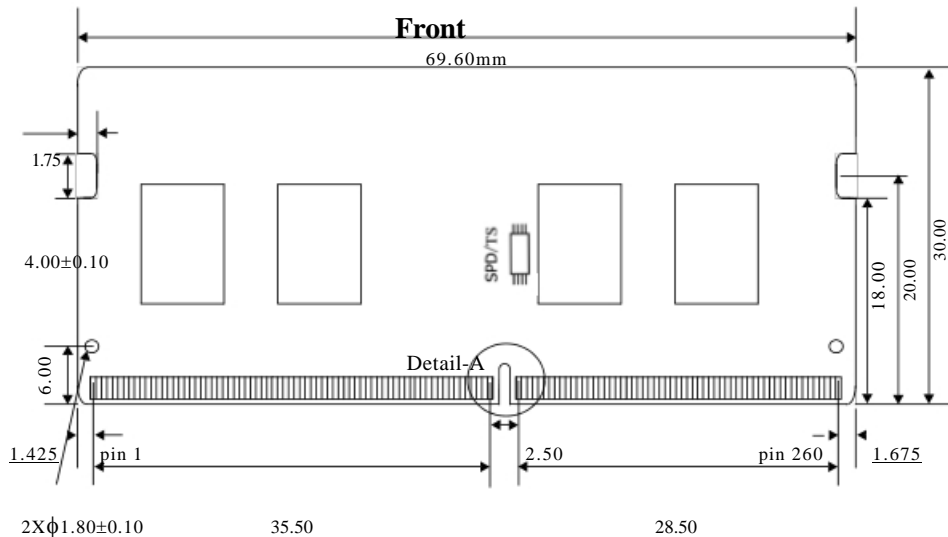

Side

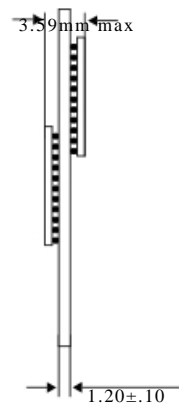

Back

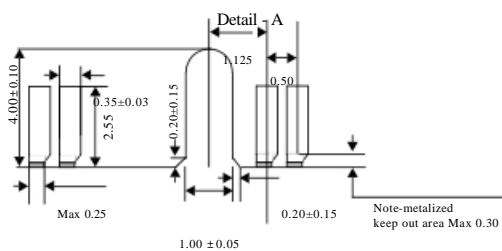
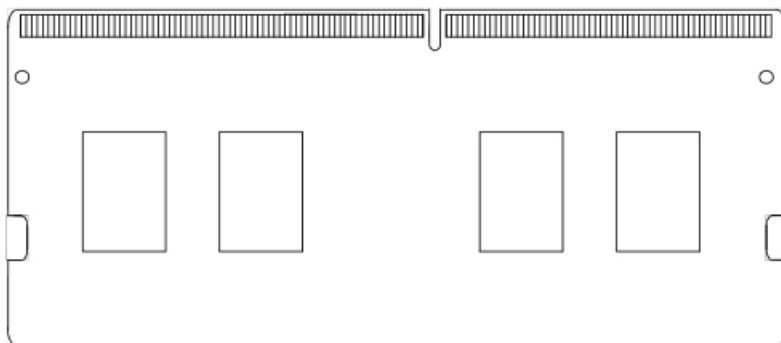

Note:

1. ±0.13 tolerance on all dimensions unless otherwise stated.

Units: millimeters